

## ELECTRICAL

## STARTER MOTORS AND RELATED PARTS

*“Consider a Modern Gear Reduction Starter...”*

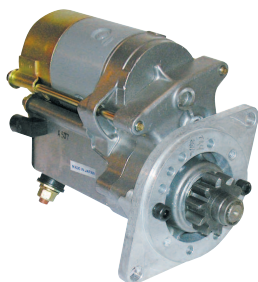

GRS102

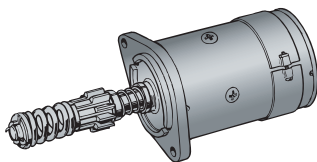

LUS2111

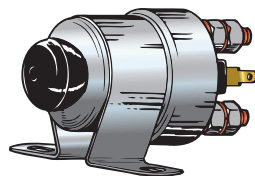

LU76495

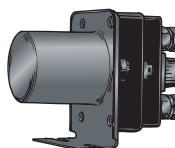

LUSRB325

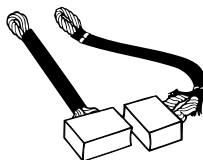

LUTAB127

Part No.	Description	No. Off	Current Prices on Website
GRS102	<b>Starter Motor</b> , modern high-torque gear reduction starter, lighter weight	1	
LUS2111	<b>Starter Motor</b> , rebuilt	1	
CORE90	Core charge on the above	1	
LU76495	<b>Solenoid</b> , starter, push-button type	1	
SLP124	<b>Cover</b> , rubber, on push-button solenoid; included with push-button solenoid	1	
LUSRB325	<b>Solenoid</b> , starter; replacement type without push button feature	1	
LUTAB127	<b>Starter Brush Set</b>	2	
LUTCB123	<b>Starter Bush</b> , commutator end	1	
LUTCB122	<b>Starter Bush</b> , driving end	1	

## FUSES AND FUSE BOXES

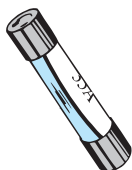

LUF35

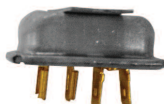

148876A



LUSFB105

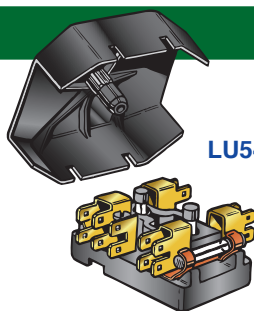

LU54038068

Part No.	Description	No. Off	Current Prices on Website
LU54038068	<b>Fuse Box</b> , with plastic cover	1	
LU54380114	<b>Cover</b> , plastic, fuse box	1	
LUF35	<b>Fuse</b> , 35-amp; English type	A/R	
LUSFB105	<b>Flasher Unit</b>	1	
128484	<b>Voltage Stabilizer</b> , positive ground, TR4	1	
148876A	<b>Voltage Stabilizer</b> , negative ground, TR4A	1	

## ELECTRICAL

## GENERATORS AND CONTROL BOXES

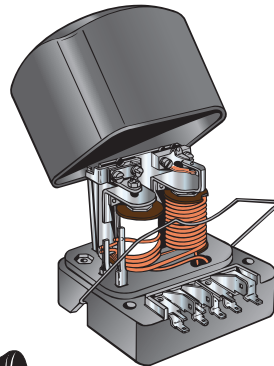
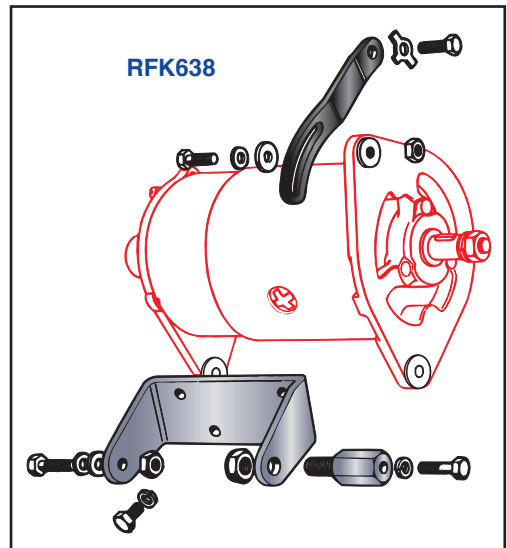
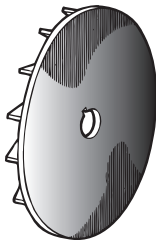
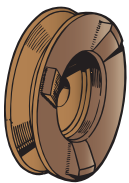
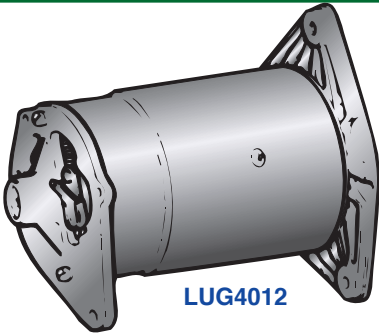

Part No.	Description	No. Off	Current Prices on Website
LUG4012	<b>Generator</b> , rebuilt	1	
CORE20	Core charge on the above	1	
205939/AL	<b>Generator</b> , new	1	
102266	<b>Pulley</b> , generator	1	
147333	<b>Fan</b> , generator	1	
LUNCB101	<b>Control Box</b>	1	
LUSPB104	<b>Generator Brush Set</b>	1	
LUUTB100	<b>Generator Bearing</b> , front	1	
LUUTB110	<b>Generator Brush</b> , rear	1	
RFK638	<b>GENERATOR MOUNTING KIT;</b> includes pedestal, link, bracket, and hardware	1	
58912	<b>Bracket</b> , bolted to block	1	
59015	<b>Pedestal</b>	1	
58914	<b>Link</b> , adjusting	1	
106706	<b>Lock Plate</b> , securing adjusting link	1	

## ELECTRICAL

## NEW DISTRIBUTORS

*“New Distributors Set Up with the Correct Advance Curve  
—Choose Points Type or Pertronix”*

Some brand new points-type distributors have appeared in the market place. Apparently, they have been assembled in India from unused parts. Regrettably, it is questionable that the correct advance springs were used. TRF is now having these distributors reworked to have not only the correct advance curves but ones which perform better with modern fuels. We are offering the same distributor with Pertronix electronic ignition conversion. All distributors are set up and tested by an expert on state of the art equipment.

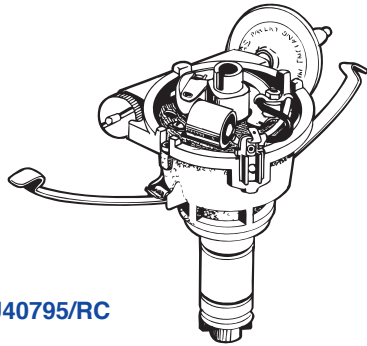

LU40795/RC

Part No.	Description	No. Off	Current Prices on Website
LU40795/RC	<b>Distributor</b> , ignition, Lucas model 25D4, brand new unit, set up and recurved by an expert, TR4, TR4A	1	
LU40795/PTXP	<b>Distributor</b> , ignition, Lucas model 25D4, as above except that a Pertronix electronic ignition kit has been installed, TR4 with positive ground	1	
LU40795/PTXN	<b>Distributor</b> , ignition, Lucas model 25D4, as above except that a Pertronix electronic ignition kit has been installed, TR4A with negative ground	1	

## REBUILT DISTRIBUTORS

*“Maintain the Originality of Your TR4 or TR4A with a Quality Rebuilt Distributor”*

If you prefer to keep your own Lucas distributor, TRF can help by having you distributor rebuilt for you. As is the case with the new units listed above, rebuilt distributors are recurved for use with modern fuels. To arrange to have your distributor rebuilt, call Dave Hagenbuch at 800 234-1104. If we rebuild a distributor for you using a core from our stock a core charge will apply.

Part No.	Description	No. Off	Current Prices on Website
LU40795/RP	<b>Distributor Rebuilt</b>	1	
CORE125	Core charge on the above	1	

## ELECTRICAL

### NEW VACUUM UNITS FOR LUCAS DISTRIBUTORS

TRF is now able to supply new vacuum units for your TR4 or TR4A, as well as for many other British cars. These units are replicas of original vacuum units and are perfect for Concours. Each vacuum unit is supplied in a replica of the old Lucas boxes.

The unit listed below is for the Lucas distributor with part number 40795. Each unit is carefully assembled and tested and is coded with the specification of the unit. You can find the part number and the codes stamped into the housing near the vacuum fitting port on your old unit.

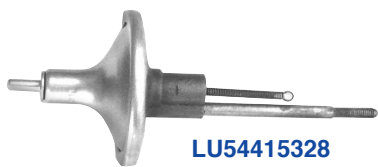

**LU54415328**



Part No.	Description	No. Off Current Prices on Website
LU54415328	<b>Vacuum Unit</b> , advance, code is 2-6-3, fits distributors with Lucas part no. 40795; vacuum unit has connecting spring and push-on fitting	1

Call Level Sales at (800) 234-1104 to inquire about new vacuum units for other Lucas distributors.

### PERTRONIX DISTRIBUTORS

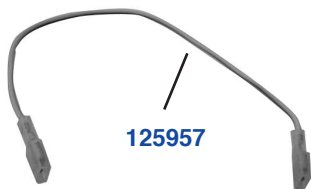

**125957**



**LU54413549**



**PTR302**

Part No.	Description	No. Off Current Prices on Website
	<b>PERTRONIX DISTRIBUTORS;</b> new distributors fitted with Pertronix Ignitor electronic ignition kit. Be sure to note the polarity of your car when ordering.	
LU41427/PTXP	<b>Distributor</b> , new; Pertronix brand with electronic ignition for TR4 with positive ground	1
LU41427/PTXN	<b>Distributor</b> , new; Pertronix brand with electronic ignition for TR4A with negative ground	1
	<b>MISC. DISTRIBUTOR FITTINGS</b>	
SLP108	<b>Screw</b> , points attachment	1
SLP109	<b>Screw</b> , condenser attachment	1
125957	<b>Low-tension lead</b> , white with black tracer	1
LU54413549	<b>Terminal and Lead</b>	1

## ELECTRICAL

## HEADLAMP ASSEMBLIES

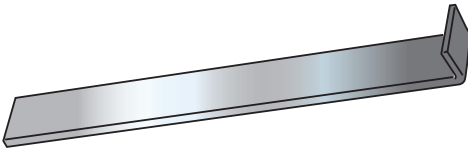
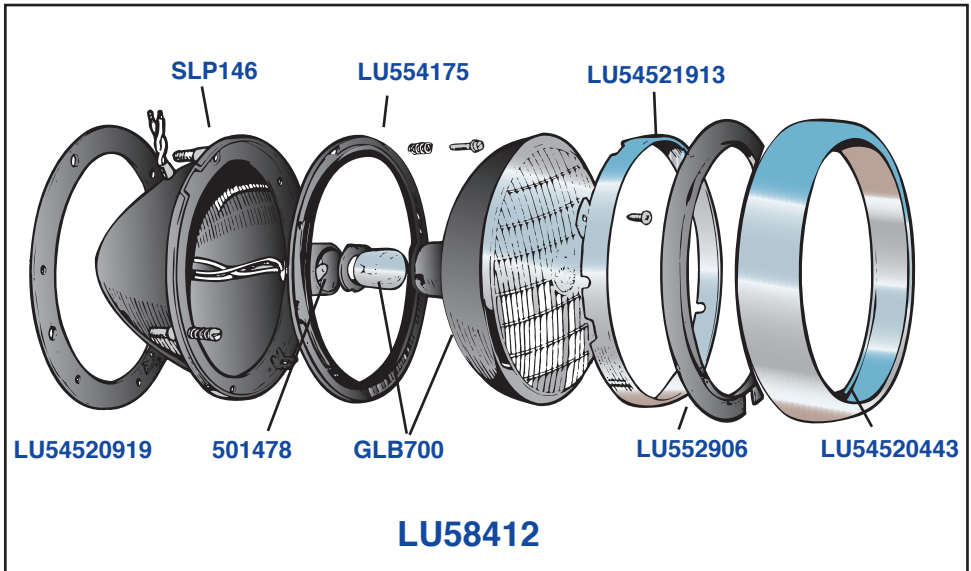

118971

Part No.	Description	No. Off	Current Prices on Website
LU58412	<b>HEADLAMP Assembly</b> , with chromed rim and sealed beam bulb, early TR4; with wide flat-sided rim, probably through 1964, up to body no. 24600CT	2	
SLP146	<b>Headlamp Bucket</b> , with clip	2	
LU54520443	<b>Headlamp Rim</b> , chromed, wide flat-sided type	2	
LU552906	<b>Rubber Seal</b> , inside headlamp rim, early rim only	2	
LU554175	<b>Plate</b> , lamp retaining, inner	2	
LU54521913	<b>Plate</b> , lamp retaining, outer	2	
AB606021	<b>Screw</b> , securing outer retaining rim to inner rim	6	
GLB700	<b>Lamp Unit</b> , sealed beam	2	
LU54520919	<b>Gasket</b> , rubber, headlamp assembly to body	2	
501478	<b>Wiring Harness</b> , headlamp	2	
LU60600427	<b>Headlamp Trimmer Kit</b> ; includes screws and plastic nuts for headlamp adjustment plus spring to anchor inner retaining plate to lamp bucket	2	
118971	<b>Tool</b> , headlamp rim removal	1	

Section Continues On Next Page

## ELECTRICAL

## HEADLAMP ASSEMBLIES—Continued

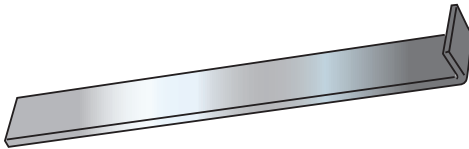
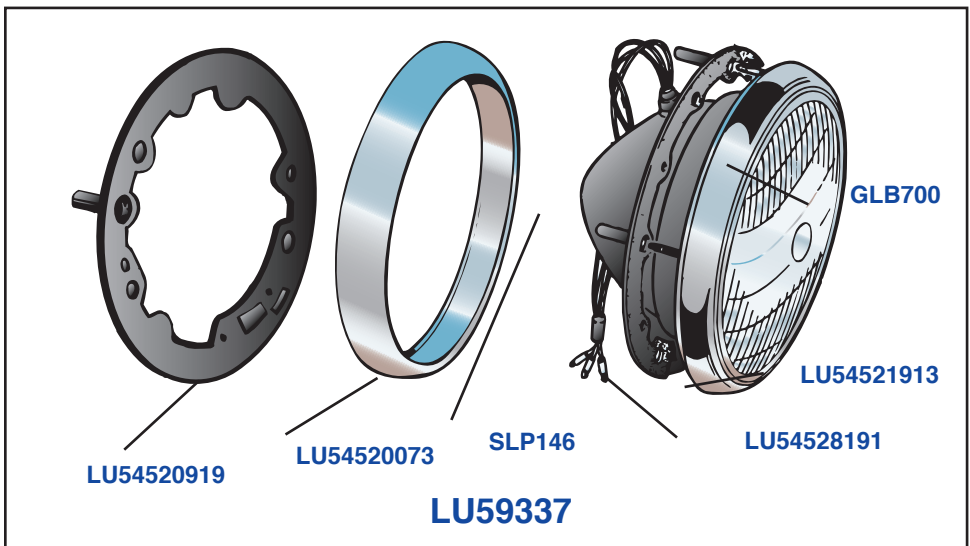

118971

Part No.	Description	No. Off	Current Prices on Website
LU59337	<b>HEADLAMP ASSEMBLY</b> , with chromed rim and sealed beam bulb, later TR4 from body no. 24601CT, all TR4A; with narrow rim	2	
SLP146	<b>Headlamp Bucket</b> , with clip	2	
LU54520073	<b>Headlamp Rim</b> , chromed, narrow type, later TR4, TR4A	2	
LU54528191	<b>Plate</b> , lamp retaining, inner	2	
LU54521913	<b>Plate</b> , lamp retaining, outer	2	
AB606021	<b>Screw</b> , securing outer retaining rim to inner rim	6	
GLB700	<b>Lamp Unit</b> , sealed beam	2	
LU54520919	<b>Gasket</b> , rubber, headlamp assembly to body	2	
501478	<b>Wiring Harness</b> , headlamp	2	
LU60600427	<b>Headlamp Trimmer Kit</b> ; includes screws and plastic nuts for headlamp adjustment plus spring to anchor inner retaining plate to lamp bucket	2	
118971	<b>Tool</b> , headlamp rim removal	1	

## ELECTRICAL

## HEADLAMPS—LIGHTING UNITS

*“Many Options to Choose from Including Replicas of the Famous Lucas Tripod lamps”*



Part No.	Description	No. Off	Current Prices on Website
GLB700	<b>Light Unit</b> , sealed beam, Wagner brand	2	
	<b>HALOGEN LAMP KITS</b> , non-Lucas		
RFK1480	<b>Headlamp Kit</b> , round-faced; kit includes two lamps and two 60/55 bulbs	1	
RFK1336	<b>Headlamp Kit</b> , round-faced, similar to classic Cibie Z-beam lamps; includes two lamps and two 60/55 bulbs	1	
RFK1337	<b>Headlamp Kit</b> , flat-faced; includes two lamps and two 60/55 bulbs	1	
	<b>LUCAS HALOGEN LAMP KITS</b>		
RFK1488	Lucas H4 Halogen Lamp Kit, round-faced with “H4” on glass; includes two lamps and two 55/60 bulbs	1	
RFK1489	<b>Lucas European H4 Lamp Kit</b> , round-faced with “Lucas European” on the glass; includes two lamps and two 55/60 bulbs	1	
	<b>REPLACEMENT BULBS FOR H4 HALOGEN LAMPS</b>		
HLB55/60	<b>Halogen Bulb</b> , H4, 60/55 watt	2	
HLB55/100	<b>Halogen Bulb</b> , H4, 100/55 watt	2	
HP700	<b>LUCAS PL700 TRI-POD LAMP KIT</b> ; high-quality replica of the original Lucas PL700 lamps; includes two lamps and two 60/55 watt H4 halogen bulbs	1	
HLB55/60	<b>Replacement Bulb</b> , for lamps in HP700 kit, 60/55 watt, H4 type	2	
HLB55/100	<b>Replacement Bulb</b> , for lamps in HP700 kit, 100/55 watt, H4 type	2	

## ELECTRICAL

## LAMPS AND LENSES

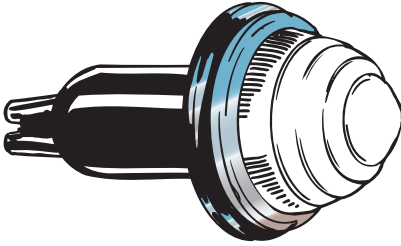

LU56461

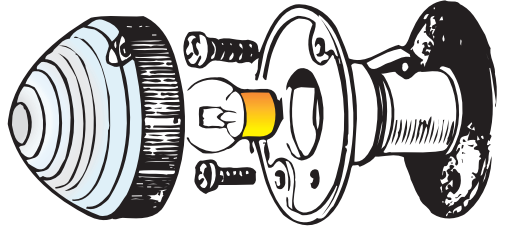

LU52649

Part No.	Description	No. Off	Current Prices on Website
<b>FRONT SIGNAL LAMPS, TR4 up to</b>			
comm. no. CT30348, glass lenses			
LU56461	<b>LAMP ASSEMBLY</b>	2	
LU54581622	<b>Lens</b> , glass, clear; as original; included with LU56461	2	
LU54581651	<b>Lens</b> , glass, amber; not originally fitted; not included with LU56461	2	
LU572734	<b>Rim</b> , chromed, retaining lens	2	
LU576105	<b>Rubber Lamp Body</b>	2	
LULLB382	<b>Bulb</b>	2	
<b>HARDWARE</b> , securing lamp to grille			
YX5363	<b>Screw</b>	4	
FS2442/4	<b>Nut</b> , fix	4	
<b>FRONT SIGNAL LAMP, TR4 after</b>			
comm. no. CT30348, TR4A; plastic lenses			
LU52649	<b>LAMP ASSEMBLY</b>	2	
LU54581109	<b>Lens</b> , plastic, clear, 3- inch diameter	2	
514422	<b>Screw</b> , securing lens to lamp	4	
514065	<b>Gasket</b> , lens seating	2	
LU573832	<b>Interior</b> , bulb holder	2	
616416	<b>Gasket</b> , lamp seating	2	
LULLB382	<b>Bulb</b>	2	
<b>HARDWARE</b> , securing lamp to grille			
YZ3305	<b>Screw</b>	6	
FJ2442/4	<b>Nut</b> , spire	6	

Section Continues On Next Page



## ELECTRICAL

## LAMPS AND LENSES—Continued



LU52737

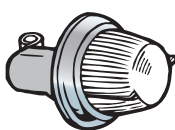

LU56466



LU54584357



LU54570578



LU54576359

Part No.	Description	No. Off	Current Prices on Website
----------	-------------	---------	---------------------------

**FRONT PARKING LAMPS, TR4; small**  
lamp fitted in upper corners of grille

LU56466	<b>LAMP ASSEMBLY</b>	2
LU54584357	<b>Lens</b> , clear with chromed ring; as original	2
LU54570578	<b>Lens</b> , amber, with chromed ring; not originally fitted	2
LU553780	<b>Interior</b> , bulbholder	2
510899	<b>Gasket</b> , lens to bulbholder	2
510900	<b>Gasket</b> , bulbholder to lamp	2
LULLB989	<b>Bulb</b>	2

**HARDWARE**, securing lamp to grille

YA324	<b>Screw</b>	4
FS2442/4	<b>Nut</b> , fix	4

**FRONT PARKING AND SIDEMARKER LAMPS,**

TR4A, mounted on front fender

LU52737	<b>LAMP ASSEMBLY</b> , L.H.	1
LU52738	<b>LAMP ASSEMBLY</b> , R.H.	1
LU54576359	<b>Lens</b> , flasher, side	2
LU54576421	<b>Gasket</b> , lens seating side lens	2
LULLB501	<b>Bulb</b> , flasher, side	2
LU54576396	<b>Gasket</b> , lamp seating, L.H.	1
LU54576379	<b>Gasket</b> , lamp seating, R.H.	1
	<b>HARDWARE</b> , lamp to fender	
WM57	<b>Washer</b> , plain	4
WL207	<b>Washer</b> , lock	4
HN2007	<b>Nut</b> , hex	4
LU56466	<b>LAMP</b> , front, clear with chromed ring	2
LU54584357	<b>Lens</b> , parking, clear, with chromed rim; as originally fitted	2
LU54570578	<b>Lens</b> , parking, amber, with chromed rim; not originally fitted	2
LU553780	<b>Interior</b> , bulbholder	2
LULLB989	<b>Bulb</b> , parking	2
510899	<b>Gasket</b> , lens to bulbholder	2
510900	<b>Gasket</b> , front lamp to lamp assembly	2
514806	<b>Screw</b> , front lamp to main lamp assembly	4

Section Continues On Next Page

## ELECTRICAL

## LAMPS AND LENSES—Continued

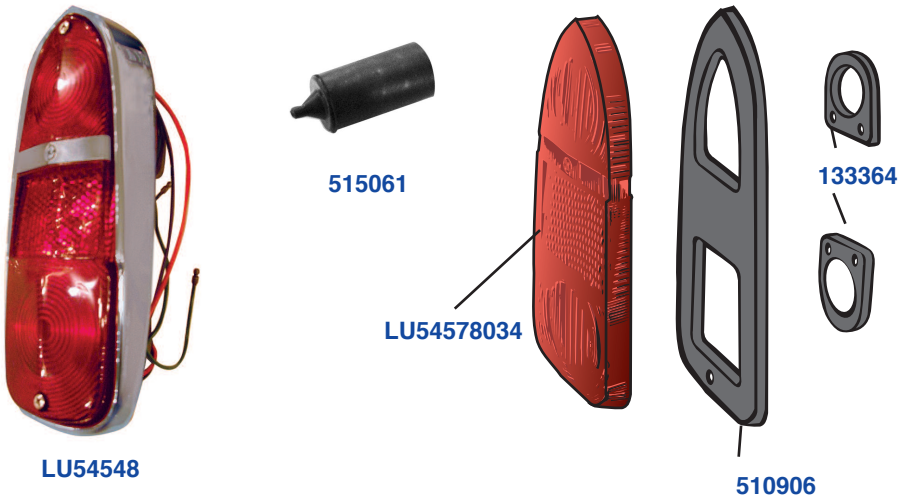

Part No.	Description	No. Off	Current Prices on Website
<b>TAIL LAMPS; red/red as original</b>			
LU54548	<b>LAMP</b> , stop/tail, with red/red lens	2	
LU54572525	<b>Base</b> , lamp	2	
LU573832	<b>Interior</b> , flasher	2	
LU573828	<b>Interior</b> , stop tail	2	
LU54578034	<b>Lens</b> , red/red, as original	2	
LU54578033	<b>Lens</b> , red/amber; not originally fitted to TR4, TR4A	2	
510904	<b>Screw</b> , securing lens, top and center	4	
510905	<b>Screw</b> , securing lens, bottom	2	
503534	<b>Washer</b> , retaining screws	6	
510906	<b>Gasket</b> , lenses to lamps	2	
LULLB382	<b>Bulb</b> , turn signal	2	
LULLB380	<b>Bulb</b> , brake and tail lamp	2	
133364	<b>Gasket</b> , lamps to car body	4	
LU54575892	<b>Grommet</b> , cable entry, signal lamps	2	
516041	<b>Grommet</b> , cable entry, stop/tail lamps	2	
<b>HARDWARE</b> , securing lamps to car			
HN2005	<b>Nut</b> , hex	8	
WN705	<b>Washer</b> , shakeproof	8	

## ELECTRICAL

## BULB KITS

*“All the Light Bulbs Needed to Service a TR4 or TR4A”*



LULLB207



LULLB987



LULLB989

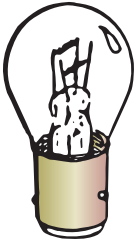

LULLB380

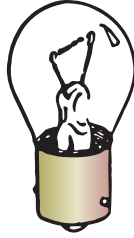

LULLB382



LULLB501

Part No.	Description	No. Off	Current Prices on Website
RFK1917	<b>BULB KIT</b> , TR4, TR4A	1	
LULLB987	<b>Bulb</b> , ignition warning lamp	1	
LULLB987	<b>Bulb</b> , turn signal warning lamp	1	
LULLB987	<b>Bulb</b> , illuminating small gauges	4	
LULLB987	<b>Bulb</b> , illuminating speedometer and tachometer	2	
LULLB382	<b>Bulb</b> , front signal lamps; single filament	2	
LULLB989	<b>Bulb</b> , front parking lamps; fitted to grille on TR4, fitted to wing lamp on TR4A	2	
LULLB501	<b>Bulb</b> , front sidemarker lamps, TR4A	2	
LULLB380	<b>Bulb</b> , tail lamps and rear brake lamps; double filament	2	
LULLB382	<b>Bulb</b> , rear turn signal lamps; single filament	2	
LULLB207	<b>Bulb</b> , rear license plate lamp	2	
LULLB987	<b>Bulb</b> , high beam warning light	1	

## ELECTRICAL

## WINDSCREEN WIPERS

If your wiper motor has stopped working, TRF can help. While we work toward stocking each of the motors listed below, the best thing is for you to send your motor to us so that you are sure of getting back the exact type of motor that was fitted to your car. To do this, send your motor to:

The Roadster Factory  
328 Killen Road  
Armagh, PA 15920

Turnaround time is about four weeks.

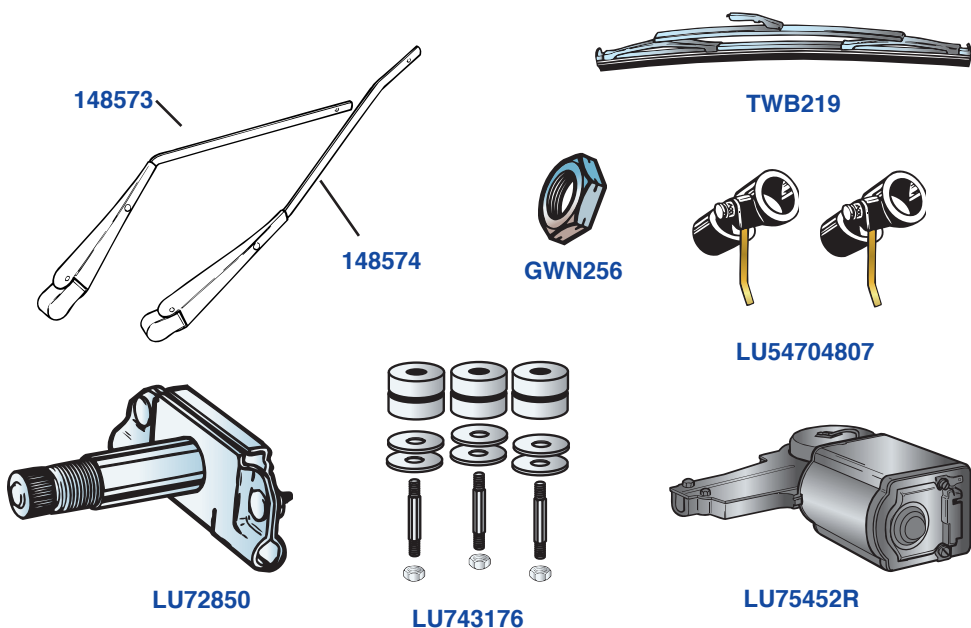

Part No.	Description	No. Off	Current Prices on Website
<b>WIPER MOTORS, rebuilt</b>			
LU75452R	<b>Wiper Motor, rebuilt, very early TR4</b>	1	
CORE50	Core charge on the above	1	
LU75456R	<b>Wiper Motor, rebuilt, later TR4</b>	1	
CORE50	Core charge on the above	1	
LU75568R	<b>Wiper Motor, rebuilt, TR4A</b>	1	
CORE50	Core charge on the above	1	
LU743176	<b>Mounting Kit, wiper motor; includes rubber mounts, studs, hardware</b>	1	
LU72850	<b>Wiper Wheelbox; includes nut</b>	2	
GWN256	<b>Chromed Nut, wheelbox</b>	2	
LU54704807	<b>Wheelbox Fitting Kit, with washer jets</b>	1	
148574	<b>Wiper Arm, L.H.</b>	1	
148573	<b>Wiper Arm, R.H.</b>	1	
TWB219	<b>Wiper Blade</b>	2	

## ELECTRICAL

## SPEEDOMETER AND TACHOMETER CABLES

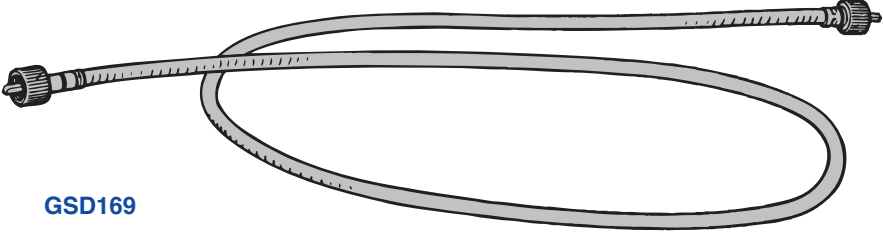
*“Grey Speedo and Tach Cables Just Like Original”*

GSD169

Part No.	Description	No. Off	Current Prices on Website
GSD169	<b>Speedometer Cable</b> , TR4, TR4A, without overdrive	1	
504609	<b>Speedometer Cable</b> , TR4 with overdrive	1	
GSD169	<b>Speedometer Cable</b> , TR4A with overdrive	1	
510234	<b>Tachometer Cable</b> , TR4, TR4A	1	

## IGNITION SWITCHES AND HEADLAMP DIP SWITCHES

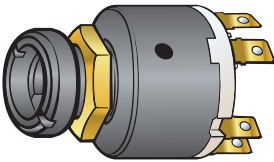

LU34680

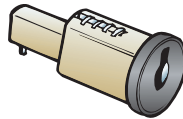

LU54316731



122759



LU34790

Part No.	Description	No. Off	Current Prices on Website
LU34680	<b>Ignition Switch</b> ; does not include lock barrel	1	
LU54316731	<b>Lock Barrel</b> , with two keys	1	
<b>HEADLAMP DIP SWITCHES</b>			
122759Z	<b>Dip Switch</b> , early TR4	1	
LU34790	<b>Dip Switch</b> , later TR4, TR4A	1	

## ELECTRICAL

## DASH SWITCHES AND KNOBS

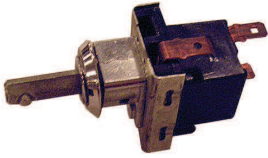

LU34317

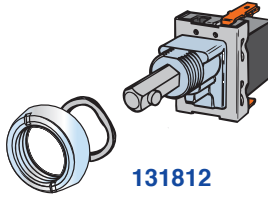

131812

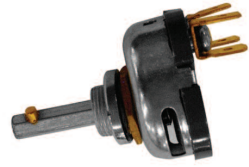

LU78511



704875



704885



704879



704883



LUSPB104

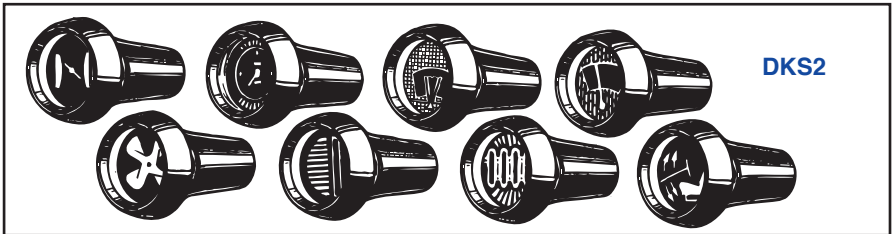

DKS2

Part No.	Description	No. Off	Current Prices on Website
----------	-------------	---------	---------------------------

**DASH SWITCHES, TR4**

131812	<b>Lighting Switch</b>	1	
704885	<b>Knob</b> , lighting switch	1	
LU78511	<b>Panel Light Rheostat Switch</b>	1	
704879	<b>Knob</b> , rheostat switch	1	
LUSPB104	<b>Windscreen Wiper Switch</b>	1	
704875	<b>Knob</b> , windscreen wiper switch	1	
LUSPB104	<b>Heater Blower Switch</b>	1	
704883	<b>Knob</b> , heater blower switch	1	

**DASH SWITCHES, TR4A**

LU34317	<b>Windscreen Wiper Switch</b>	1	
704887	<b>Knob</b> , windscreen wiper switch	1	
LU78511	<b>Panel Light Rheostat Switch</b>	1	
704879	<b>Knob</b> , rheostat switch	1	
LUSPB104	<b>Heater Blower Switch</b>	1	
704883	<b>Knob</b> , heater blower switch	1	

DKS2	<b>DASH KNOB SET</b> ; includes all of the following indented knobs, TR4, TR4A	1	
704885	<b>Knob</b> , lighting switch, TR4	1	
704879	<b>Knob</b> , panel lamps, TR4, TR4A	1	
704875	<b>Knob</b> , windscreen wiper switch, TR4	1	
609946	<b>Knob</b> , windscreen washer switch, TR4, TR4A	1	
704873	<b>Knob</b> , choke pull, TR4, TR4A	1	
704884	<b>Knob</b> , water control cable	1	
704883	<b>Knob</b> , blower switch	1	
704881	<b>Knob</b> , air flow cable	1	
704887	<b>Knob</b> , windscreen wiper switch	1	

## ELECTRICAL

## STEERING COLUMN SWITCHES

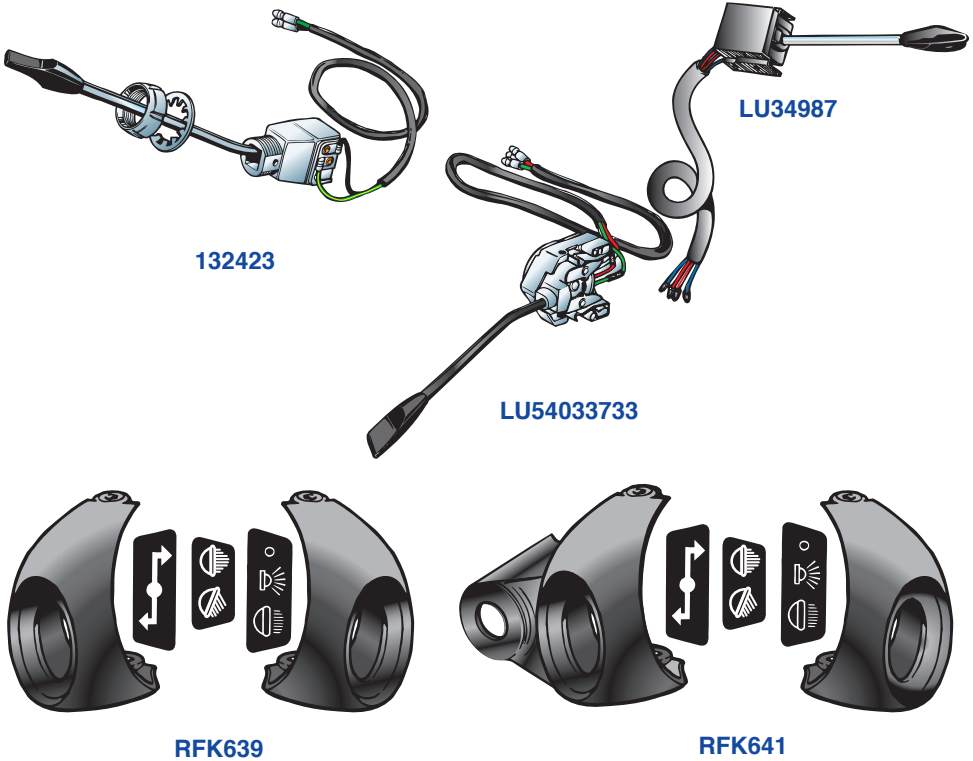

Part No.	Description	No. Off	Current Prices on Website
----------	-------------	---------	---------------------------

### STEERING COLUMN LIGHTING SWITCHES, TR4A only

LU34987	<b>Lighting Switch</b> , chro­med handle, TR4A only, fitted to right side of column	1	
---------	---	---	--

LU54033733	<b>Turn Signal Switch</b> , black handle, TR4, TR4A	1	
------------	---	---	--

### STEERING COLUMN OVERDRIVE SWITCHES

132423	<b>Overdrive Switch</b> , TR4, fitted to right side of steering column, chro­med handle	1	
--------	---	---	--

139794	<b>Overdrive Switch</b> , TR4A, fitted to left side of steering column, chro­med handle	1	
--------	---	---	--

### SWITCH ESCUTCHEONS KITS, black plastic escutcheons with decals and hardware; TR4A; inquire about using RFK639 on TR4 in place of original metal escutcheons

RFK639	<b>Escutcheon Kit</b> , without overdrive	1	
RFK641	<b>Escutcheon Kit</b> , with overdrive	1	

## ELECTRICAL

## STEERING COLUMN SWITCHES



611974



708479



611011



611013

Part No.	Description	No. Off	Current Prices on Website
<b>INDIVIDUAL SWITCH COVERS</b>			
708479	<b>Escutcheon</b> , black plastic, turn signal switch, TR4	1	
708479	<b>Escutcheon</b> , black plastic, overdrive switch, TR4	1	
708479	<b>Escutcheon</b> , black plastic, turn signal switch, TR4A without overdrive	1	
611974	<b>Escutcheon</b> , black plastic, turn signal switch and overdrive switch, TR4A with overdrive	1	
708479	<b>Escutcheon</b> , black plastic, lighting switch, TR4A	1	
611011	<b>Decal</b> , turn signal switch	1	
611013	<b>Decal</b> , three-position lighting switch	1	

## BRAKE LIGHT SWITCHES

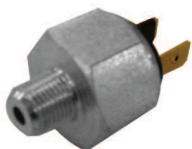

56865

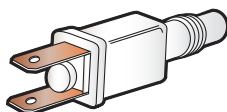

LU34933

Part No.	Description	No. Off	Current Prices on Website
<b>BRAKE LIGHT SWITCHES</b>			
56865	<b>Brake Lamp Switch</b> , hydraulic; on five-way fitting mounted to chassis, TR4 up to comm. no. CT26929	1	
LU34933	<b>Brake Lamp Switch</b> ; on brake master cylinder bracket, later TR4 after comm. no CT26930, TR4A	1	



## ELECTRICAL

## DASH WARNING LIGHTS, TR4, TR4A



LULLB987



501347



128378

Part No.	Description	No. Off	Current Prices on Website
501347	<b>Ignition Warning Light</b> , red lens	1	
LULLB987	<b>Bulb</b> , ignition warning light	1	
128378	<b>Flasher Warning Light</b> , green lens	1	
LULLB987	<b>Bulb</b> , flasher warning light	1	

## HORNS

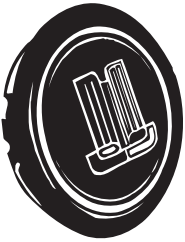

150277

608462



LU54301407

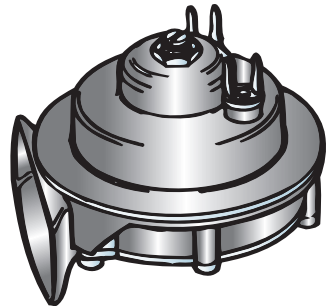

SLP175

RFK646

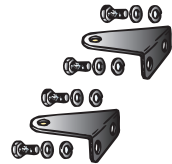

Part No.	Description	No. Off	Current Prices on Website
	<b>HORN BUTTONS, TR4, TR4A</b>		
150277	<b>Horn Button</b> , with Triumph crest	1	
204741	<b>Spring Clip</b> , securing horn button	1	
608462	<b>Contact Plate</b> , behind steering wheel, mounted to top of steering column	1	
LU54301407	<b>Contact Tube</b>	1	
	<b>HORNS</b>		
SLP175	<b>Horn</b> , metal, low note	1	
SLP174	<b>Horn</b> , metal, high note	1	
RFK646	<b>Horn Mounting Kit</b> ; includes two horn mounting brackets plus hardware to mount two horns	1	

# ELECTRICAL

## WIRING HARNESSES

### *“Easier to Install Than You Would Think”*

Wiring harnesses are colour-coded as original for easy installation. Replace your cobbled harness for safety and better performance.

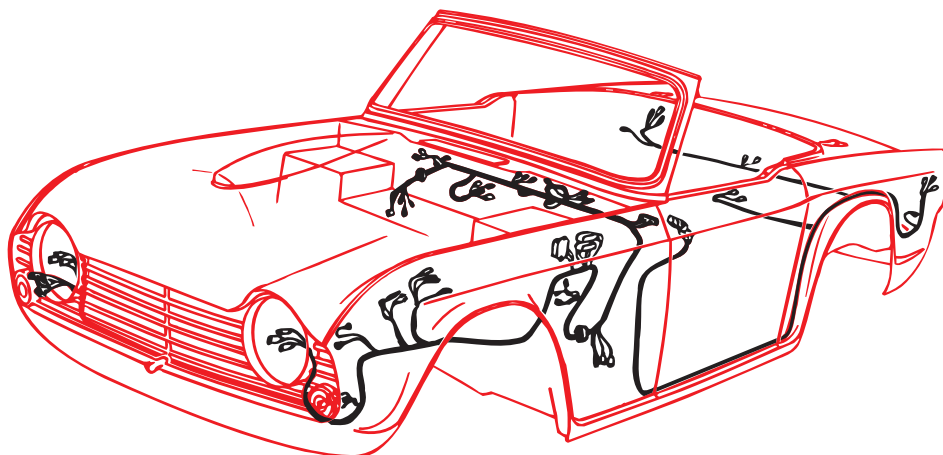

Part No.	Description	No. Off	Current Prices on Website
<b>MAIN WIRING HARNESSES</b>			
305281	<b>Main Wiring Harness</b> , TR4, up to comm. no. CT9983, blue vinyl harness wrap	1	
305611	<b>Main Wiring Harness</b> , TR4, from comm. no. CT9984 to CT26999, blue vinyl harness wrap	1	
306645	<b>Main Wiring Harness</b> , TR4, after comm. no. CT26999, blue vinyl harness wrap	1	
307234	<b>Main Wiring Harness</b> , TR4A, black vinyl harness wrap	1	
<b>SUPPLEMENTARY WIRING HARNESSES</b>			
501478	<b>Wiring Lead Assembly</b> , headlamps; with plug	2	
147777	<b>Wiring Lead Assembly</b> , reverse lamp switch	1	
125957	<b>Wiring Lead</b> , from distributor to coil	1	
131338	<b>Wiring Harness</b> , from overdrive switch to overdrive relay	1	
131339	<b>Wiring Harness</b> , from overdrive relay to gearbox switches and overdrive solenoid	1	

## ELECTRICAL

## BATTERY RELATED COMPONENTS

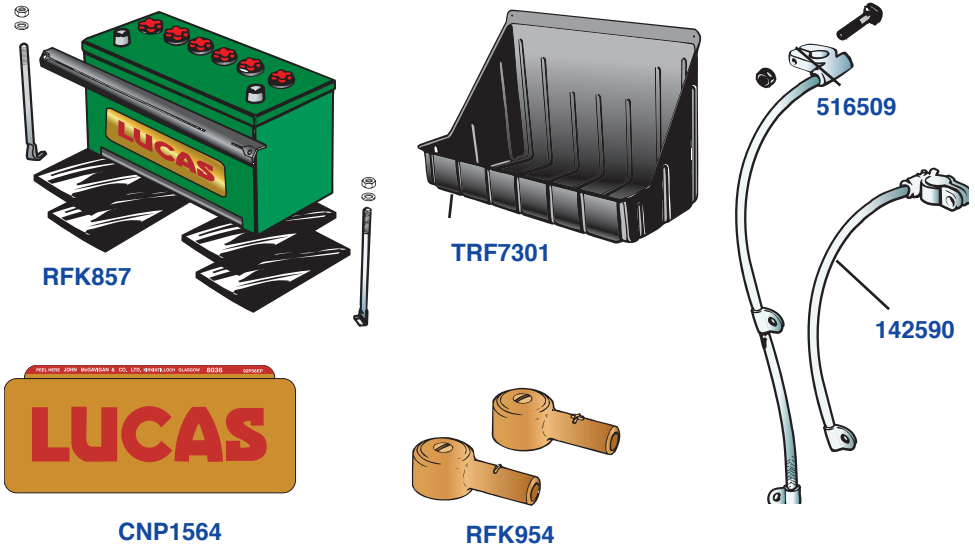

Part No.	Description	No. Off Current Prices on Website
RFK857	<b>BATTERY HOLD-DOWN KIT, TR4, TR4A</b>	1
601898	<b>Battery Angle</b>	1
610798	<b>J-hook</b>	2
YN2907	<b>Nyloc Nut</b> ; as supplied in kit	2
132068	<b>Wing Nut</b> , alternative to YN2907; not supplied in kit	2
WM57	<b>Plain Washer</b>	2
602945	<b>Rubber Pad</b> , under battery	4
TRF7301	<b>Plastic Battery Tray</b> ; to protect battery shelf from battery acid	1
CNP1564	<b>Lucas battery Sticker</b> ; red on gold, fits most batteries	1
RFK954	<b>Helmet Cable Ends Kits</b> ; includes positive and negative helmet ends	1
	<b>BATTERY CABLES, TR4</b> ; these do not have helmet ends	
131113	<b>Cable</b> , with terminals, battery to ground	1
131115	<b>Cable</b> , with terminals, battery to solenoid	1
131114	<b>Cable</b> , with terminals, solenoid to starter	1
LUCMB114	<b>Cable</b> , with terminals, engine to ground	1
	<b>BATTERY CABLES, TR4A</b> ; these do not have helmet ends	
142590	<b>Cable</b> , with terminals, battery to ground	1
516509	<b>Cable</b> , with terminals, battery to solenoid	1
131114	<b>Cable</b> , with terminals, solenoid to starter	1
131116	<b>Cable</b> , engine to ground	1
130581	<b>Cable</b> , grounding; at steering joint	1
134301	<b>Cable</b> , grounding, steering rack to chassis	1