

# INTERIOR

## GEARBOX TUNNELS, PROP SHAFT COVERS

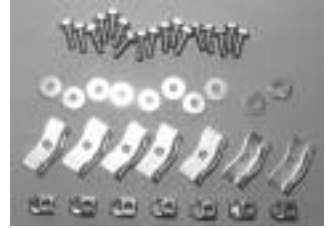

RFK157

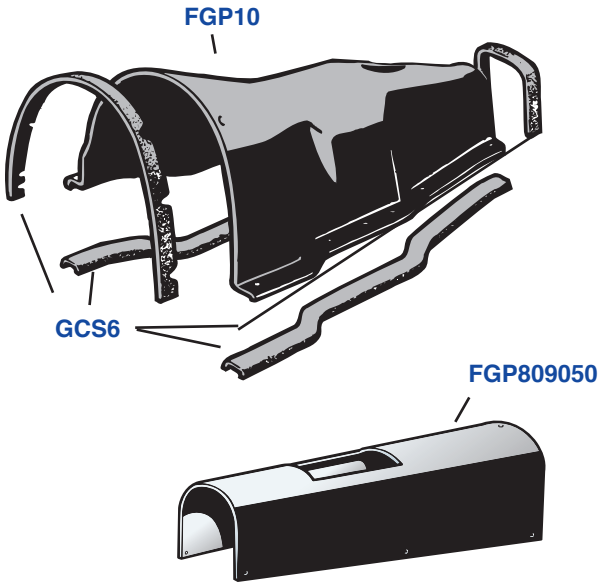
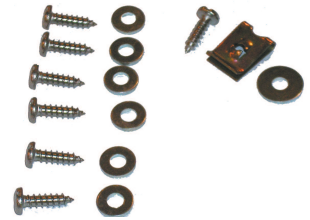

RFK1064

Part No.	Description	No. Off	Current Prices on Website
RFK779	<b>GEARBOX COVER AND INSTALLATION KIT;</b> includes gearbox cover, rubber seal kit; and correct mounting hardware, all TR4, TR4A	1	
FGP10	<b>Gearbox Cover,</b> heavy duty moulded plastic	1	
GCS6	<b>Rubber Seal Kit,</b> to seal cover to floor and bulkhead; cement seals to cover	1	
RFK157	<b>Hardware Kit,</b> securing cover to floor and bulkhead; includes all the correct hardware to do the job	1	
<b>DRIVE SHAFT TUNNEL DETAILS, TR4A</b>			
FGP809050	<b>Drive Shaft Tunnel,</b> heavy duty moulded plastic, TR4A only	1	
RFK1064	<b>Hardware Kit,</b> for installing cover to prop shaft tunnel	1	

## INTERIOR

### CARPET SETS FOR TR4, TR4A MANUFACTURER BY THE MAGIC CARPET FACTORY



## The Magic Carpet Factory

### *“Simply the Best”*

#### CARPET MATERIALS

The Roadster Factory offers carpet sets for TR4 and TR4A in materials to match those in which Triumph manufactured the carpet sets when the cars were new.

The TR4 was originally supplied with rayon loop carpet in charcoal grey regardless of interior colour. For concours purposes, this is what you will want to have. In addition, we can supply TR4 carpet sets in rayon loop in black, red, tan, and blue. Rayon is a man-made material and it has less of a shine than nylon loop carpet available elsewhere. Although not used in the TR4, TRF can supply TR4 carpet sets in wool or tufted in a wide variety of colours.

The original carpet material for the TR4A was Wilton wool as listed in the following catalogue sections. As the TR4A carpet pattern is the same as TR250 and TR6, we are also listing carpet sets in the less-expensive tufted carpet as fitted to later TR6 as well as a range of tufted carpet for TR4.

#### WORKMANSHIP

Many interior shops across the country have commented about how much they like carpet sets from The Magic Carpet Factory and how easy they are to fit to cars. There are good reasons for this. Patterns were carefully developed from original carpet pieces taken from original cars. Care was taken to insure that every detail, indeed every stitch, of the original carpet sets was accounted for in the patterns. New carpet sets were then manufactured and refitted to the original cars, and the pieces were adapted to insure that the fit was perfect. Fibreboard backing boards were manufactured for kick panel carpets, as were half-moon rubber protection pads and rubber heel mats. Handbrake boots and handbrake boot grommets were duplicated, and they are hand-tailored onto every carpet set manufactured. In the final analysis, carpet sets from The Magic Carpet Factory include more original details than you get at virtually any interior shop.

#### COLOUR CHOICES

Customer colour choices are available to match any interior colour scheme, and because every carpet set is made especially for every order within a week or two of the time the order is received, virtually any binding colour can be used on any carpet colour. Carpet sets manufactured by The Magic Carpet Factory offer customers the choices they would have at a fine custom trim shop at off-the-shelf prices.

# INTERIOR The Magic Carpet Factory

## CARPET SETS, TR4

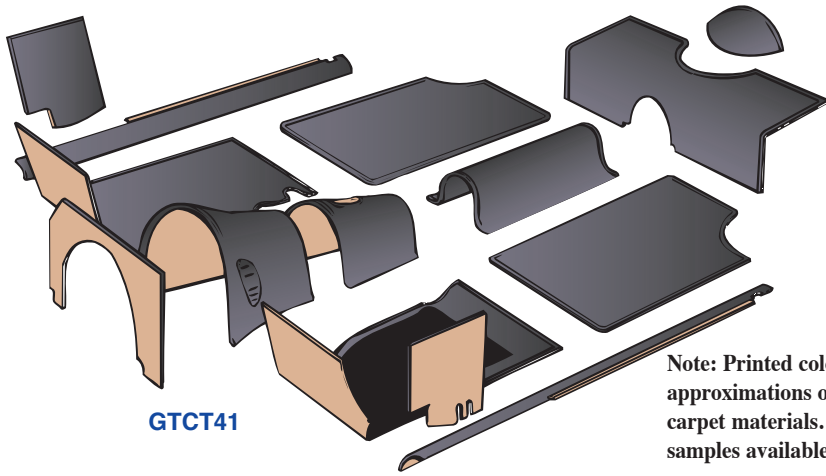

GTCT41

Note: Printed colours are approximations of actual carpet materials. Free samples available.

Part No.	Description	No. Off	Current Prices on Website
----------	-------------	---------	---------------------------

### RAYON-LOOP PILE CARPET SETS, TR4;

grey appears to have been fitted to all TR4's but we give you a choice of additional colours

GTCT41	<b>Carpet Set</b> , rayon loop; please specify colour, charcoal grey, black, red, blue, or tan	1	
--------	--	---	--

### WILTON WOOL CARPET SETS, TR4

models; listed as an upgrade for models originally fitted with rayon loop pile carpet

GTCT42	<b>Carpet Set</b> , Wilton Wool; please specify colour desired, black, bright red, darker red, geranium, blue, brown, tan, stone, or grey	1	
--------	---	---	--

### TUFTED CARPET SETS, TR4 models;

offered as an alternative to wool or rayon-loop carpet sets listed above; similar look to wool at prices comparable to rayon loop

GTCT42TN	<b>Carpet Set</b> , tufted; please specify colour desired, black, red, dark red, shadow blue, navy blue, light tan, medium tan, dark tan, or grey	1	
----------	---	---	--

## UNDERFELT AND CARPET INSTALLATION, TR4

CUF4/J

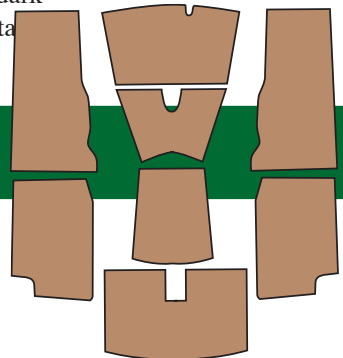

Part No.	Description	No. Off	Current Prices on Website
----------	-------------	---------	---------------------------

CUF4/J	<b>Carpet Underfelt Kit</b> , original jute	1	
CUF4/S	<b>Carpet Underfelt Kit</b> , synthetic material	1	
RFK1218	<b>Installation Kit</b> , TR4; with glue	1	
RFK1397	<b>Installation Kit</b> , TR4; without glue	1	

## INTERIOR



## The Magic Carpet Factory

## CARPET SETS, TR4A

Note: Printed colours are approximations of actual carpet materials. Free samples available.

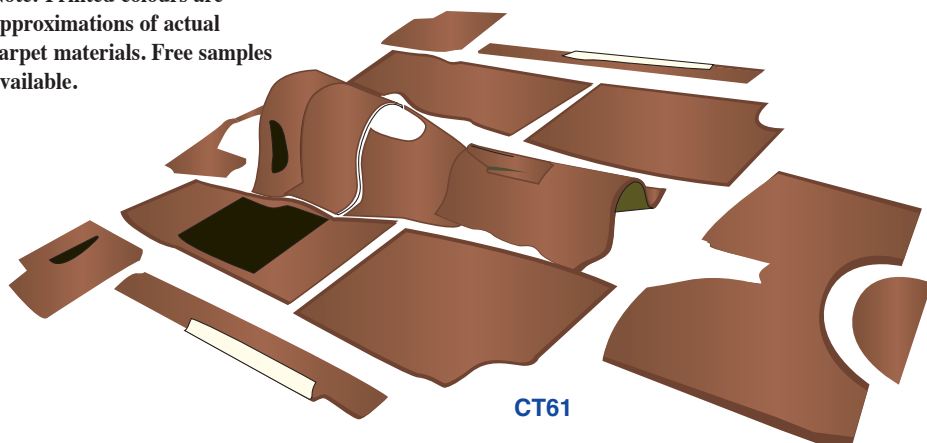

Part No.	Description	No. Off	Current Prices on Website
----------	-------------	---------	---------------------------

**WILTON WOOL CARPET SETS,**

TR4A models; as originally fitted

CT61

**Carpet Set**, Wilton Wool; please specify colour desired, black, bright red, darker red, geranium, blue, brown, tan, stone, or grey

1

**TUFTED CARPET SETS,**

TR4A models; less expensive alternative to wool

CT62

**Carpet Set**, tufted; please specify colour desired, black, darker red, midnight blue, navy blue, grey, light tan, medium tan, or dark tan

1

## UNDERFELT AND CARPET INSTALLATION, TR4A

CUF6/J

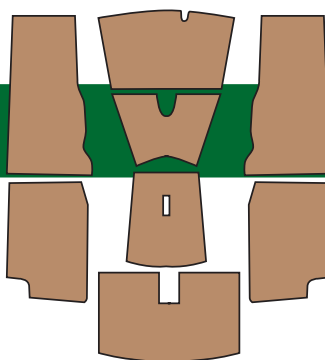

Part No.	Description	No. Off	Current Prices on Website
----------	-------------	---------	---------------------------

CUF6/J

**Carpet Underfelt Kit**, original jute material

1

CUF6/S

**Carpet Underfelt Kit**, synthetic material

1

RFK174

**Carpet Installation Kit**, TR4A; with glue

1

RFK1108

**Carpet Installation Kit**, TR4A; without glue

1

# INTERIOR

## CARPET INSTALLATION HARDWARE

Listings of popular fittings contained in installation kits listed in prior sections

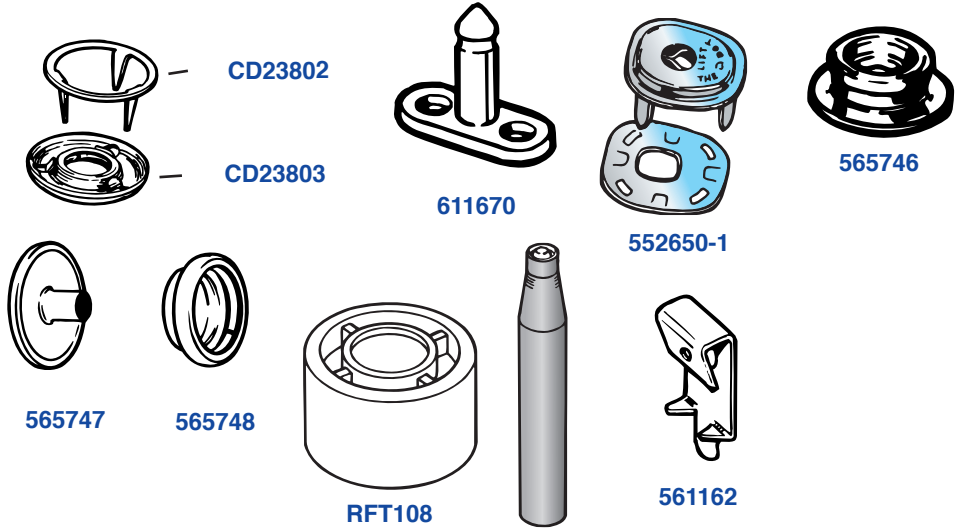

Part No.	Description	No. Off	Current Prices on Website
----------	-------------	---------	---------------------------

### STANDARD DOT CARPET SNAPS

CD23803	<b>Snap Socket</b> , fitted to underside of carpet	A/R
CD23802	<b>Pronged Ring</b> , to be pushed through carpet to secure snap sockets	A/R
565746	<b>Snap</b> , stud, securing carpets to floor, with small center hole to be secured with a pop rivet	A/R
554407	<b>Pop Rivet</b> , securing snaps	A/R

### LIFT-THE-DOT SNAPS; securing rear shelf carpet, TR4 only

552650-1	<b>Snap Socket and Clinch Plate</b>	4
611670	<b>Snap Stud</b>	4
YA365	<b>Screw</b> , securing snap studs to floor	8

### CARPET CLIPS, securing front floor carpets or OEM rubber mats to bulkhead

561162	<b>Spring Clip</b>	4
554407	<b>Pop Rivet</b> , securing spring clips	4

### DOT SNAPS, TR4, TR4A

565747	<b>Snap Button</b> , outer part	A/R
565748	<b>Snap Socket</b> , female part	A/R
565746	<b>Snap Stud</b> , with small hole to be secured with pop rivets	A/R
554407	<b>Pop Rivet</b> , securing snap stud	A/R

RFT108	<b>SNAP INSTALLATION TOOL;</b> inexpensive tool for installing snaps listed above; use this tool for DOT snaps; snap studs require a pop rivet tool	1
--------	--	---

## INTERIOR

### RUBBER FLOOR MATS

Traditional black rubber floor mats originally made by Amco and supplied by Triumph dealers and by Amco when the cars were new with Triumph shield emblems.

**TRF6819-2**

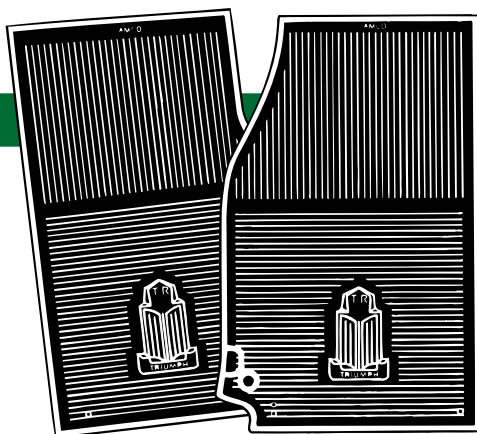

Part No.	Description	No. Off	Current Prices on Website
TRF6819-2	<b>Rubber Floor Mat Set</b> , black, one pair	1	

### GEARSHIFT BOOTS

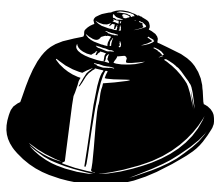

**705913**



**709328**



**705402**



**709329**



**622381**



**610942**

Part No.	Description	No. Off	Current Prices on Website
<b>GEARSHIFT BOOTS</b>			
705913	<b>Gearshift Boot</b> , TR4	1	
709329	<b>Gearshift Boot</b> , lower section, TR4A	1	
709328	<b>Gearshift Boot</b> , upper, moulded rubber as original	1	
622381	<b>Gearshift Boot</b> , upper, TR6 type; sewn vinyl boot with moulded rubber boot; nice upgrade	1	
<b>RUBBER BRAKE BOOT DETAILS, TR4 only</b>			
705402	<b>Rubber Boot</b> , handbrake lever	1	
610942	<b>Steel Plate</b> , securing rubber boot to floor	1	
RFK1891	<b>Fitting Kit</b> , brake boot and plate to floor	1	

# INTERIOR

## GEARSHIFT KNOBS

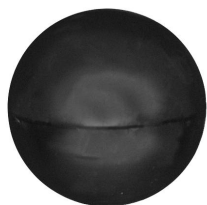

131246



148870/WBW



148870/WRB



TRF8326-7

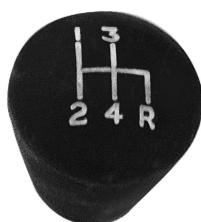

156138



148870

Part No.	Description	No. Off	Current Prices on Website
	<b>ORIGINAL KNOB, TR4, TR4A</b>		
131246	<b>Gearshift Knob</b> , as original, round knob, no shift pattern	1	
	<b>ACCESSORY KNOBS</b>		
148870/WBW	<b>Knob</b> , gearshift lever, walnut, with Triumph shield emblem in blue and white	1	
148870/WRB	<b>Knob</b> , gearshift lever, walnut, with Triumph shield emblem in red and black	1	
TRF8326-7	<b>Gearshift Knob</b> , black vinyl, with Triumph shield emblem	1	
	<b>TR250, TR6 STYLE KNOBS; nice upgrade</b>		
156138	<b>Gearshift Knob</b> , pear-shaped, black with shift pattern	1	
148870	<b>Gearshift Knob</b> , black leather with silver gearshift emblem	1	
NT605041	<b>Nut</b> , jam	1	

## INTERIOR

## CRASH PADS, TR4, TR4A

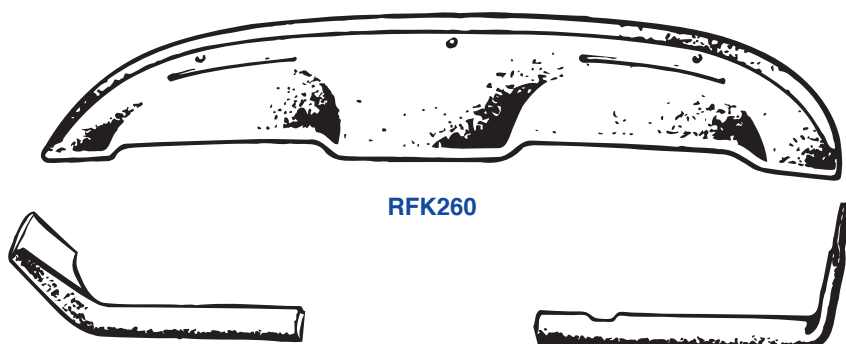

RFK260

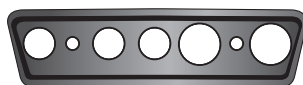

706882

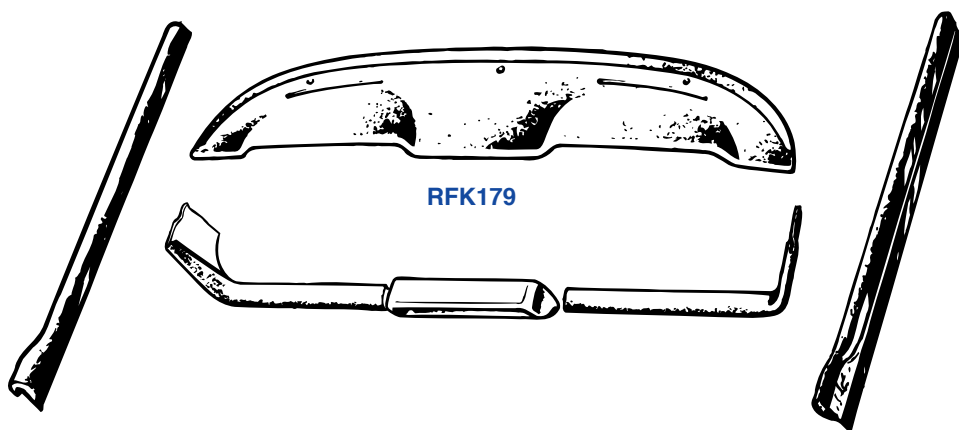

RFK179

Part No.	Description	No. Off	Current Prices on Website
RFK260	<b>CRASH PAD SET, TR4</b>	1	
904115	<b>Crash Pad</b> , dash top	1	
812081	<b>Crash Pad</b> , lower dash, L.H.	1	
808733	<b>Crash Pad</b> , lower dash, R.H.	1	
706882	<b>Center Switch Plinth</b> , TR4; not included in kit listed above	1	
RFK179	<b>CRASH PAD SET, TR4A</b>	1	
904115	<b>Crash Pad</b> , dash top	1	
812081	<b>Crash Pad</b> , lower dash, L.H.	1	
808733	<b>Crash Pad</b> , lower dash, R.H.	1	
809003	<b>Switch Plinth</b>	1	
808228	<b>Door Top Pad</b> , L.H.	1	
808229	<b>Door Top Pad</b> , R.H.	1	



# INTERIOR

## DASH SUPPORTS ASSEMBLIES AND RECOVERING KITS, TR4 ONLY



Part No.	Description	No. Off	Current Prices on Website
REP423	<b>Dash Support Assembly</b>	1	
REP321	<b>Recovering Kit</b> , dash support, for later style dash support that is flat around the gear shift lever hole, earlier dash supports had a slight “volcano” shape	1	
RFK432	<b>Hardware Kit</b> , mounting dash support to dash and to floor	1	
623201	<b>Cap</b> , black plastic, hiding heads of screws; included in hardware kit	2	
617069	<b>Radio Aperture Blanking Plate</b>	1	



A supply of recovered dash supports from The Magic Carpet Factory.

## INTERIOR

### WOOD DASH PANELS

*“Made at The Roadster Factory by Our Own Chuck Findley”*

If you ever have the opportunity to visit The Roadster Factory, your tour will include the little wood shop at the back of one of the warehouses where our wood working craftsman Chuck Findley produces wood dash panels to factory specifications from scratch. Chuck, who we have affectionately nicknamed “Wood Chuck,” starts by pressing veneer onto marine grade plywood. He cuts each dash panel out using precision templates. After much sanding, a clear coat of finish is applied. Edges and backs of each panel are painted brown as original. The grain on TR4 and TR4A dash panels are book-matched as original. Glovebox doors are carefully fitted using chromed hinges and correct hardware.

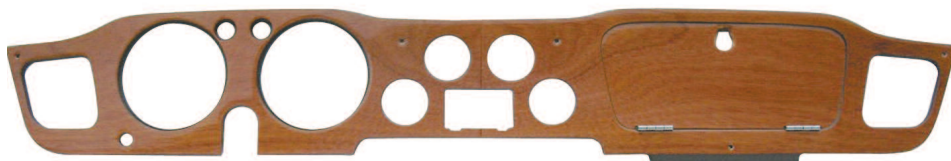

WDP41

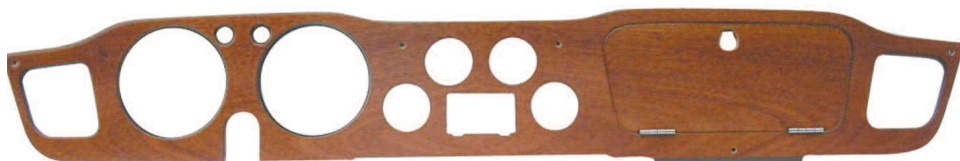

WDP42

Part No.	Description	No. Off	Current Prices on Website
WDP41	<b>Wood Dash Panel</b> , chrome-plated hinges, TR4; fitted as an option by the factory to some models; may be retrofitted	1	
WDP42	<b>Wood Dash Panel</b> , chrome-plated hinges, TR4A	1	
RFK227	<b>Hardware Kit</b> , dash installation; chromed screws and cup washer	1	

# INTERIOR

## GLOVE BOXES

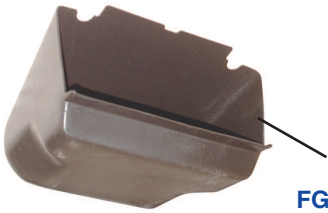

FGP805135

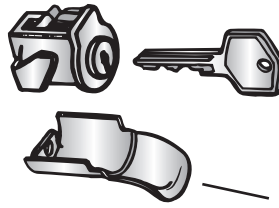

611584



609463

Part No.	Description	No. Off	Current Prices on Website
FGP805135	<b>Glove Box</b> , precision moulded plastic, TR4, TR4A	1	
RFK430	<b>Hardware Kit</b> , for installing glove box	1	
611584	<b>Lock</b> , glove box door, with keys	1	
609463	<b>Finger-pull</b> , chromed; fitted along with lock	1	

## SUN VISORS

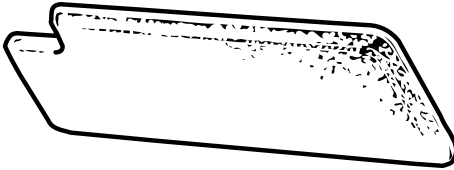

705754

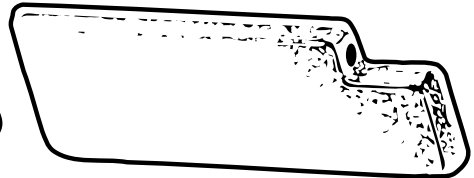

705754

Part No.	Description	No. Off	Current Prices on Website
705754	<b>Sun Visor</b> , white, TR4 only; old mounting hardware must be used	2	

## INTERIOR MIRRORS



611102

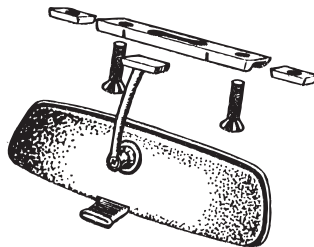

632095



RTC1006

Part No.	Description	No. Off	Current Prices on Website
611102	<b>Mirror</b> , interior, TR4	1	
632095	<b>Mirror</b> , interior, TR6 type, day/night feature	1	
RTC1006	<b>Breakaway Bracket</b> , for 632095 mirror; included with mirror	1	

## INTERIOR

## TRIM PANEL KITS

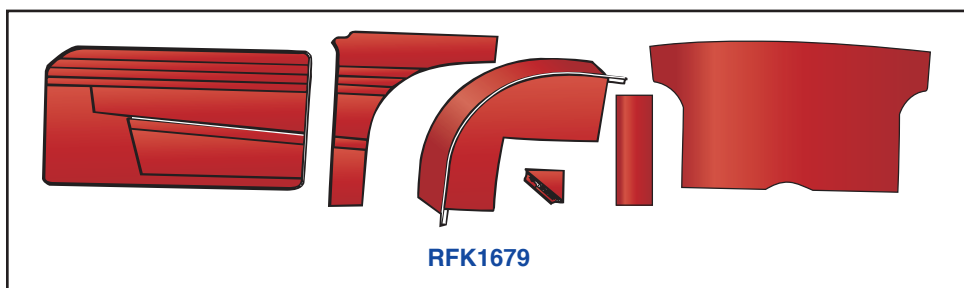
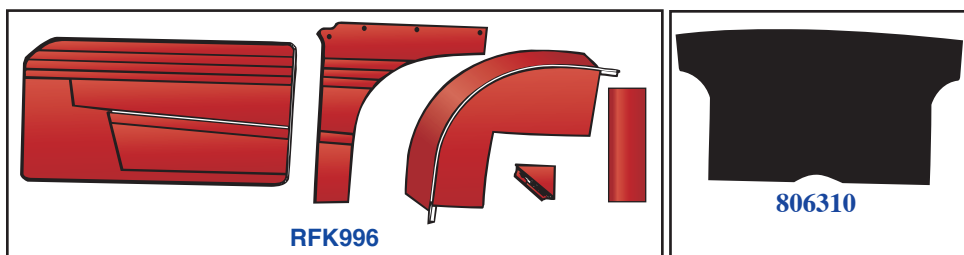

Note: Printed colours are approximations of actual vinyl and leather materials. Free samples available.

Part No.	Description	No. Off	Current Prices on Website
	<b>TR4 TRIM PANEL KITS;</b> for cars fitted with soft tops; includes door panels, rear quarter panels, wheelarch covers, door post reinforcements, and vinyl for rear door posts; now includes rear bulkhead board		
RFK995	<b>Trim Panel Kit,</b> TR4, black with white piping	1	
RFK996	<b>Trim Panel Kit,</b> TR4, red with white piping	1	
RFK997	<b>Trim Panel Kit,</b> TR4, midnight blue with white piping	1	
806310	<b>Rear Bulkhead Board,</b> TR4 soft top models, black fibreboard; now included in trim panel kits	1	
	<b>TR4 TRIM PANEL KITS,</b> for cars fitted with surrey tops; includes door panels, rear quarter panels, wheelarch covers, rear bulkhead board, door post reinforcements, and vinyl for rear door posts		
RFK1678	<b>Trim Panel Kit,</b> TR4, black with white piping	1	
RFK1679	<b>Trim Panel Kit,</b> TR4, red with white piping	1	
RFK1680	<b>Trim Panel Kit,</b> TR4, midnight blue with white piping	1	

Section Continues On Next Page

# INTERIOR

## TRIM PANEL KITS—Continued

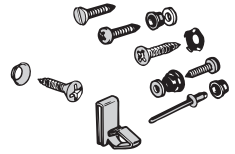
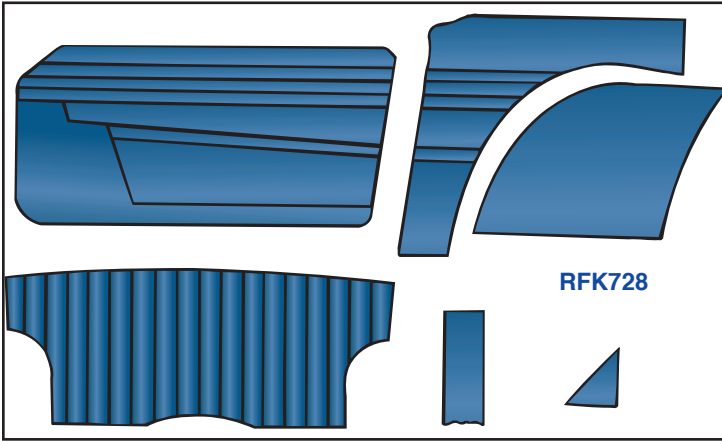

RFK1104

Note: Printed colours are approximations of actual vinyl and leather materials. Free samples available.



621991 Black



621997 Blue



621992 Red

Part No.	Description	No. Off	Current Prices on Website
	<b>TR4A TRIM PANEL KITS;</b> includes door panels, rear quarter panels, wheelarch covers, bulkhead panel, door post reinforcements, and vinyl for rear door posts rear bulkhead board		
RFK725	<b>Trim Panel Kit,</b> TR4A, black with white piping	1	
RFK726/BRD	<b>Trim Panel Kit,</b> TR4A, red with white piping	1	
RFK728	<b>Trim Panel Kit,</b> TR4A, midnight blue with white piping	1	
	<b>HARDWARE AND FITTINGS FOR TRIM PANELS</b>		
RFK1104	<b>HARDWARE KIT,</b> for installing a full set of interior trim panels; including required hardware except for coloured door pocket screw caps listed below	1	
507819	<b>Trim Screw,</b> chromed	A/R	
CD24152	<b>Cup Washer,</b> chromed	A/R	
GHF1230	<b>Trim Panel Clip</b>	A/R	
YZ3426	<b>Door Pocket Screw</b>	4	
608586	<b>Pronged Clip,</b> door pocket screws	4	
	<b>DOOR POCKET CAPS</b>		
621991	<b>Cap,</b> black	4	
621992	<b>Cap,</b> red	4	
621997	<b>Cap,</b> blue	4	

## INTERIOR

## TRUNK TRIM COMPONENTS



806837

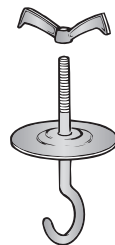

RFK468

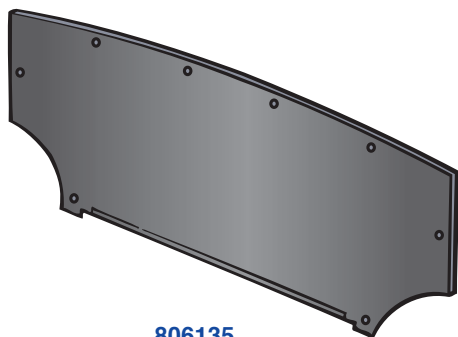

806135

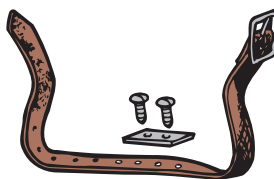

RFK645

Part No.	Description	No. Off	Current Prices on Website
806135	<b>Casing Board</b> , rear of fuel tank	1	
RFK1132	<b>Hardware Kit</b> , securing casing board; includes all correct hardware	1	
806837	<b>Trunk Floor Panel</b> , TR4, TR4A, as original	1	
RFK468	<b>Spare Tire Retaining Kit</b> ; includes hook bolt, large washer, and large wing nut	1	
RFK645	<b>Belt Kit</b> , securing tool kit; includes belt with buckle, and mounting hardware	1	

# INTERIOR

## SEAT REUPHOLSTERY, TR4 ONLY

### *“TR4 Seat Springs Now Available Exactly as Original”*

TRF has developed its own seat spring units for TR4. TRF’s spring units are made to factory specifications using numerous rows of thin and thick springs as opposed to heavy modern springs used by other suppliers.



GTSRK321



RFK258

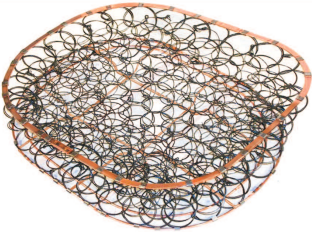

806222

**Note: Printed colours are approximations of actual vinyl and leather materials. Free samples available.**

Part No.	Description	No. Off	Current Prices on Website
<b>VINYL SEAT REUPHOLSTERY</b>			
<b>KITS, early TR4</b>			
GTSRK321/BLK	<b>Seat Kit</b> , black with white piping	1	
GTSRK321/RED	<b>Seat Kit</b> , red with white piping	1	
GTSRK321/BLU	<b>Seat Kit</b> , midnight blue with white piping	1	
<b>LEATHER SEAT REUPHOLSTERY</b>			
<b>KITS, early TR4; leather seat facings with vinyl sides and backs as original</b>			
GTSRK322/BLK	<b>Seat Kit</b> , black with white piping	1	
GTSRK322/RED	<b>Seat Kit</b> , red with white piping	1	
GTSRK322/BLU	<b>Seat Kit</b> , midnight blue with white piping	1	
<b>ADDITIONAL COMPONENTS</b>			
806222	<b>Spring Case</b> , seat bottom	2	
RFK258	<b>Seat Padding Kit</b> ; includes original horsehair and burlap components	1	

Section Continues On Next Page



## INTERIOR

## SEAT REUPHOLSTERY, TR4 ONLY — Continued

*“TR4 Seat Springs Now Available Exactly as Original”*

TRF has developed its own seat spring units for TR4. TRF’s spring units are made to factory specifications using numerous rows of thin and thick springs as opposed to heavy modern springs used by other suppliers.



GTSRK325



RFK258

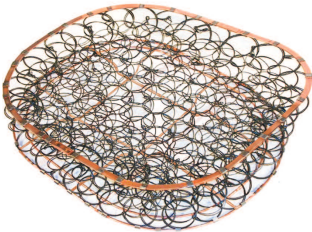

806222

Note: Printed colours are approximations of actual vinyl and leather materials. Free samples available.

Part No.	Description	No. Off Current Prices on Website
----------	-------------	-----------------------------------

### VINYL SEAT REUPHOLSTERY KITS,

mid-range TR4; similar to previous listing but with vertical pleats rather than horizontal pleats

GTSRK425/BLK	<b>Seat Kit</b> , black with white piping	1
GTSRK425/RED	<b>Seat Kit</b> , red with white piping	1
GTSRK425/MBL	<b>Seat Kit</b> , midnight blue with white piping	1

### LEATHER SEAT REUPHOLSTERY

**KITS**, mid-range TR4; leather seat facings with vinyl sides and backs as original, vertical pleats

GTSRK426/BLK	<b>Seat Kit</b> , black with white piping	1
GTSRK426/RED	<b>Seat Kit</b> , red with white piping	1
GTSRK426/MBL	<b>Seat Kit</b> , midnight blue with white piping	1

### ADDITIONAL COMPONENTS

806222	<b>Spring Case</b> , seat bottom	2
RFK258	<b>Seat Padding Kit</b> ; includes original horsehair and burlap components	1

Section Continues On Next Page



# INTERIOR

## SEAT REUPHOLSTERY, TR4 ONLY — Continued

GTSRK421



SFK41

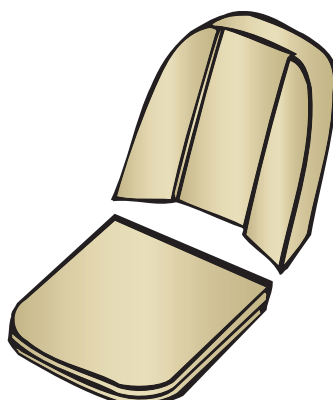

821137

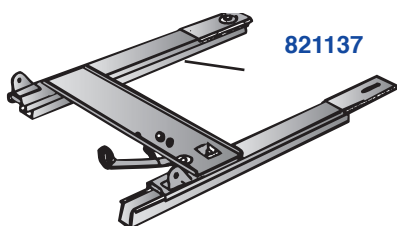

RFK1133

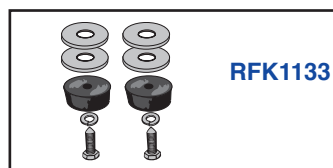

612251

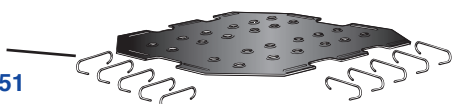

Note: Printed colours are approximations of actual vinyl and leather materials. Free samples available.

Part No.	Description	No. Off	Current Prices on Website
----------	-------------	---------	---------------------------

### VINYL SEAT REUPHOLSTERY KITS,

latest TR4

GTSRK421/BLK	<b>Seat Kit</b> , black with white piping	1
GTSRK421/RED	<b>Seat Kit</b> , red with white piping	1
GTSRK421/BLU	<b>Seat Kit</b> , midnight blue with white piping	1

### LEATHER SEAT REUPHOLSTERY

**KITS**, latest TR4; leather seat facings with vinyl sides and backs as original

GTSRK422/BLK	<b>Seat Kit</b> , black with white piping	1
GTSRK422/RED	<b>Seat Kit</b> , red with white piping	1
GTSRK422/BLU	<b>Seat Kit</b> , midnight blue with white piping	1

### ADDITIONAL COMPONENTS

SFK41	<b>Seat Foam Kit</b>	1
612251	<b>Rubber Diaphragm</b> , with hooks	2
821137	<b>Seat Track Assembly</b> ; fits LH or RH, mounting hardware sold separately	2
RFK1133	<b>Buffer Kit</b> , seat, fitted to bottom of seat frame; includes two rubber buffers and attachment hardware	2

## INTERIOR

## SEAT REUPHOLSTERY KITS, TR4A ONLY



GTSRK431

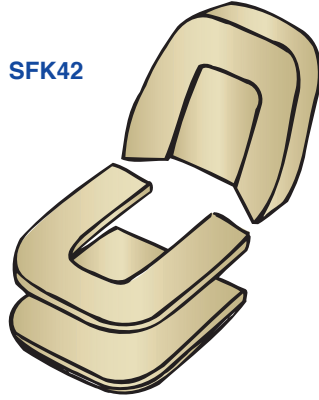

SFK42

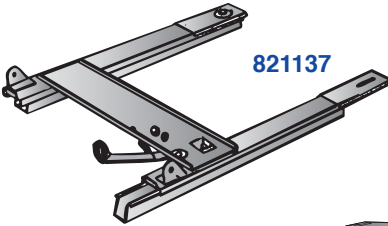

821137

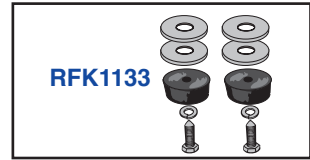

RFK1133

612251

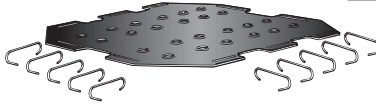

Part No.	Description	No. Off	Current Prices on Website
----------	-------------	---------	---------------------------

## VINYL SEAT REUPHOLSTERY KITS,

TR4A

GTSRK431/BLK	<b>Seat Kit</b> , black with white piping	1	
GTSRK431/RED	<b>Seat Kit</b> , red with white piping	1	
GTSRK431/BLU	<b>Seat Kit</b> , midnight blue with white piping	1	

## LEATHER SEAT REUPHOLSTERY KITS,

TR4A; leather seat facings with vinyl sides and backs as original

GTSRK432/BLK	<b>Seat Kit</b> , black with white piping	1	
GTSRK432/RED	<b>Seat Kit</b> , red with white piping	1	
GTSRK432/BLU	<b>Seat Kit</b> , midnight blue with white piping	1	

## ADDITIONAL COMPONENTS

SFK42	<b>Seat Foam Kit</b>	1	
612251	<b>Rubber Diaphragm</b> , with hooks	2	
821137	<b>Seat Track Assembly</b> ; fits LH or RH , mounting hardware sold separately	2	
RFK1133	<b>Buffer Kit</b> , seat, fitted to bottom of seat frame; includes two rubber buffers and attachment hardware	2	

## INTERIOR

### JUMP SEATS, TR4

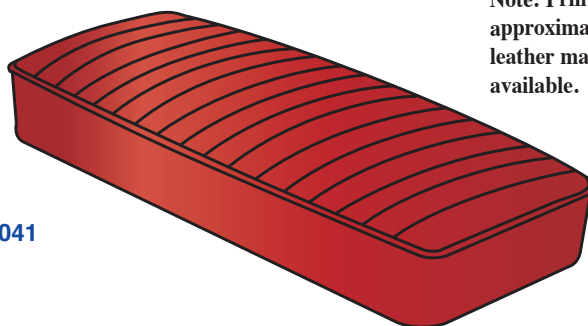

706041

Note: Printed colours are approximations of actual vinyl and leather materials. Free samples available.

Part No.	Description	No. Off Current Prices on Website
	<b>JUMP SEATS</b> , vinyl; fitted to rear shelf, TR4	
706043	<b>Jump Seat</b> , vinyl, black with white piping	1
706041	<b>Jump Seat</b> , vinyl, red with white piping	1
706042	<b>Jump Seat</b> , vinyl, midnight blue with white piping	1
	<b>JUMP SEATS</b> , leather face with vinyl sides, TR4	1
706051	<b>Jump Seat</b> , leather, black with white piping	1
706049	<b>Jump Seat</b> , leather, red with white piping	1
706050	<b>Jump Seat</b> , leather, midnight blue with white piping	1

### JUMP SEATS, TR4A

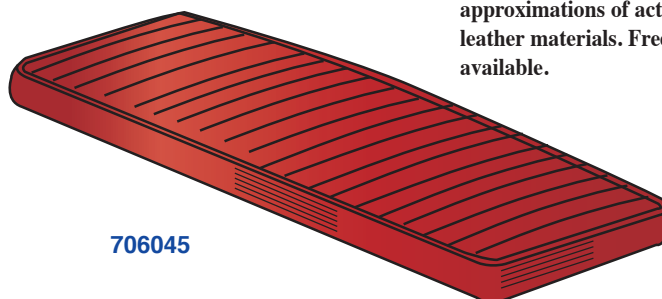

706045

Note: Printed colours are approximations of actual vinyl and leather materials. Free samples available.

Part No.	Description	No. Off Current Prices on Website
	<b>JUMP SEATS</b> , vinyl; fitted to rear shelf, TR4A	
706047	<b>Jump Seat</b> , vinyl, black with white piping	1
706045	<b>Jump Seat</b> , vinyl, red with white piping	1
706046	<b>Jump Seat</b> , vinyl, midnight blue with white piping	1
	<b>JUMP SEATS</b> , leather face with vinyl sides, TR4A	
706055	<b>Jump Seat</b> , leather, black with white piping	1
706053	<b>Jump Seat</b> , leather, red with white piping	1
706054	<b>Jump Seat</b> , leather, midnight blue with white piping	1

## INTERIOR

## SEAT BELTS

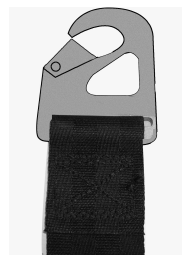
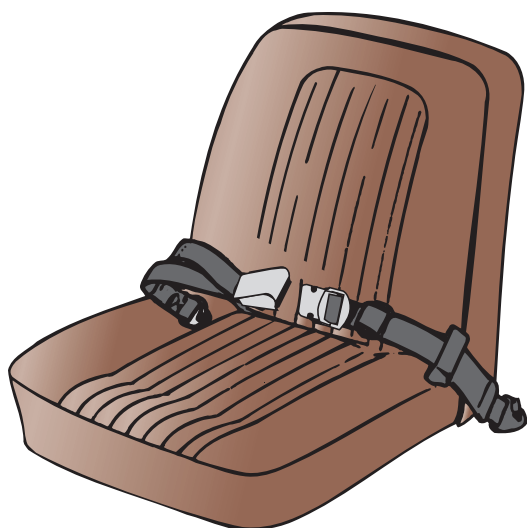

Hook on seat belt  
no. TRFSB103

## TRFSB102

Part No.	Description	No. Off	Current Prices on Website
TRFSB102	<b>Seat Belt Kit</b> , lap belt only; attaches to the floor with bolts and nuts, requires holes to be drilled; please specify colour from chart below	2	
TRFSB103	<b>Seat Belt Kit</b> , lap belt only, hook type; belts include hooks that attach to eye bolts as found on some cars; includes new eye bolts; please specify colour from chart below	2	

**Colours Available:**

Colour No.	Trim Colour
1000	Black
2006	Bright Red
2007	Matador Red
4002	Shadow Blue
4004	Navy Blue
3000	Light Tan
3005	Chestnut (dark brown)